

ENERGY POWER



MARKETED BY
1800 Roswell Road, Suite #2200
Marietta, GA 30062
1-888-823-0954

www.energybattery.com

EP-SLA12-150 FT

12V 150 AMP H



SEALED RECHARGEABLE BATTERY



FEATURES:

- Superior performance with Absorbent Glass Mat (AGM) technology
- Safe operation with valve regulated, spill proof construction
- Unrivalled performance of delivered energy of any battery in its class
- UL Certified under file # MH47790
- Rugged impact resistant ABS case and cover
- Ease of movement with integrated ABS carrying handles
- Approved for transport by air. D.O.T., I.A.T.A., F.A.A. and C.A.B. certified

To ensure safe and efficient operations please refer to www.energybattery.com. All specifications subject to change without notice.

TERMINALS (mm):

Bolt

Recessed type

Tolerance +/- 0.1mm. All data subject to change without notice.

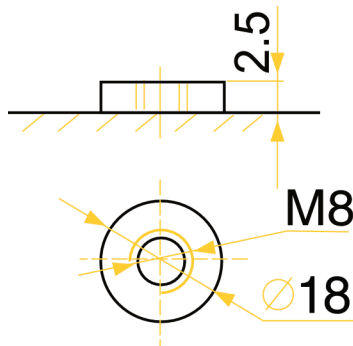

PHYSICAL DIMENSIONS:

	inches	mm
L:	21.69	551
W:	4.33	110
H:	11.34	288
HT:	11.34	288

Tolerance +/- 2mm. All data subject to change without notice.

PERFORMANCE SPECIFICATIONS:

Nominal Voltage 1.80V/cell
Nominal Capacity (25°C (77°F))
 10-hr. F.V.(1.80V/cell) 150.00 Ah
Approximate Weight 101.41 lbs (46.00 kgs)
Internal Resistance (approx.)..... 4.5 milliohms
Case..... ABS Plastic

Capacity Affected by Temperature (at 20 hour rate)
 40°C..... 102%
 25°C..... 100%
 0°C 85%
 -15°C 65%

Self-discharge (remaining capacity % at 25°C)
 3 Months..... 91%
 6 Months..... 82%
 12 Months..... 64%

TRICKLE (OR FLOAT) SERVICE LIFE

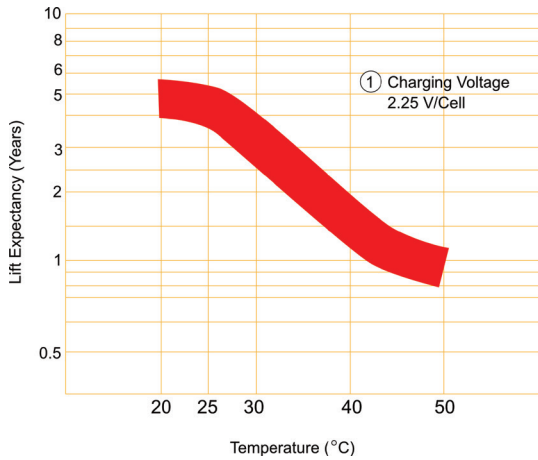

TERMINAL VOLTAGE AND DISCHARGE TIME

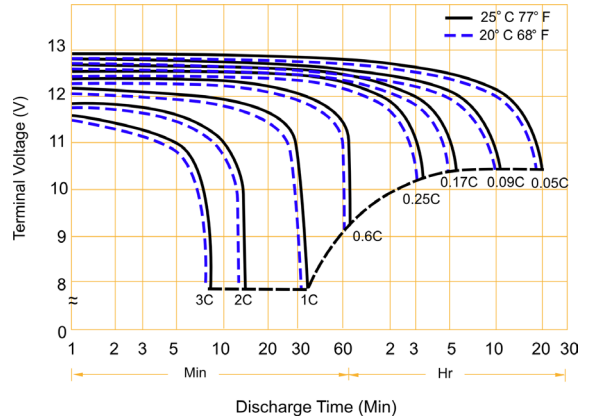

BATTERY CHARGING CHARACTERISTICS FOR STANDBY USE

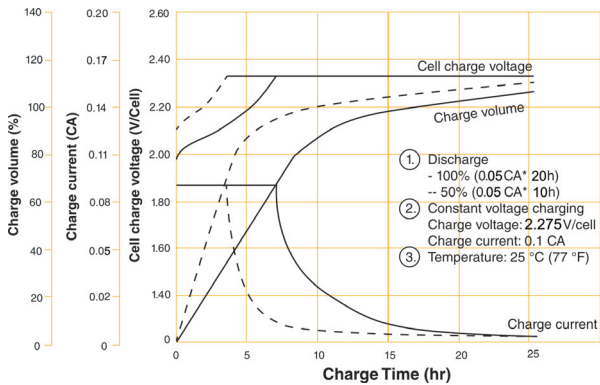

BATTERY CHARGING CHARACTERISTICS FOR CYCLIC USE

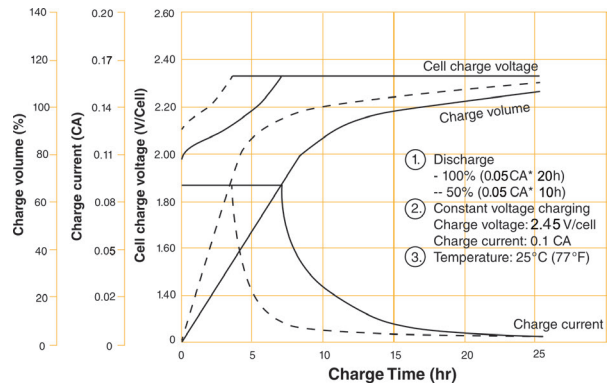

BATTERY CHARGE CHARACTERISTICS FOR CYCLE USE & STAND-BY USE

Application	Charge Voltage (V/Cell)			Max. charging current (CA)
	Temperature	Set Point	Allowable Range	
For standby power source	25 C	2.275	2.25~2.30	0.3C
For cycle service	25 C	2.450	2.40~2.50	0.3C

